







5BB Multi-crystalline Solar PV Modules

ASP-6-AAA (AAA=255-270) | 60 Cells | 255-270 Wp

Highlights

-  More power/m² compared to industry average
-  Higher specific energy yield (kwh/kwp) due to superior cell + module engineering
-  Superior performance at NOCT and PCT conditions
-  Superior low light irradiation performance 200w/m²
-  Resistant to PID, salt mist and Ammonia
-  Triple EL checking to ensure defect free modules.

Reduces installation costs by 2%	Reduces transport costs by 2%	Reduces land costs by 2%	Reduces BOS costs by 2%
----------------------------------	-------------------------------	--------------------------	-------------------------

Average power 60 cell multi-crystalline module

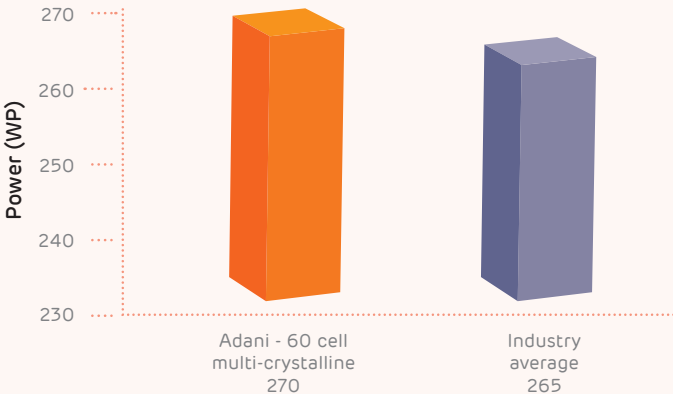

Current-voltage curve

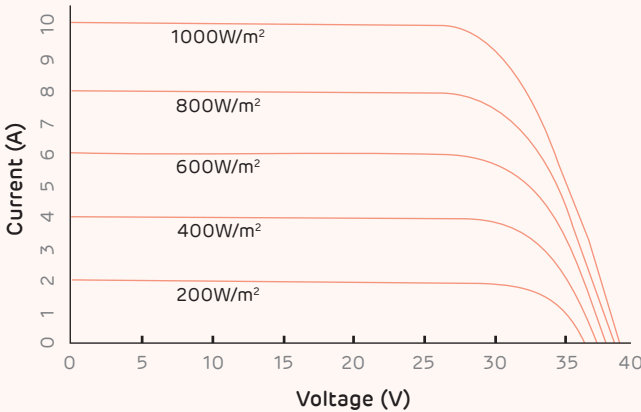

Note: Data is based on the comparison of the Adani -60 cells standard multi (270Wp) with industry's average of 265 Wp module for a scale of 1 MW installation and cost reduction will vary from site to site.

Technical Data

Solar

Dimensions in mm

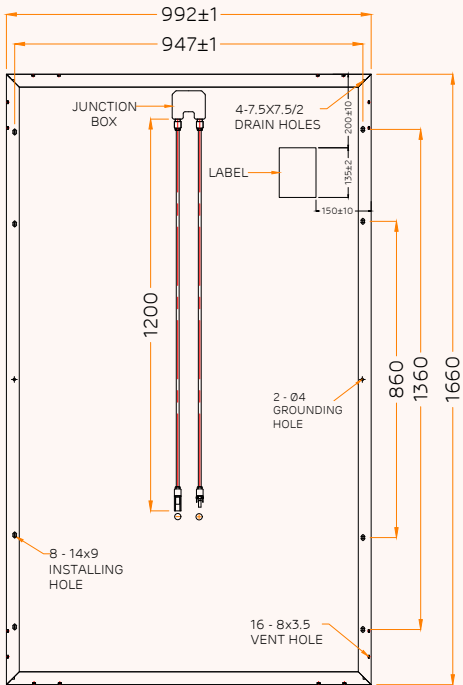

Electrical data-All data refers to STC

Peak power, (0 ~+ 4.99 Wp) Pmax(Wp)	250	255	260	265	270
Maximum voltage, Vmpp (V)	30.59	30.81	31.11	31.41	31.71
Maximum current, Impp (A)	8.19	8.29	8.38	8.45	8.53
Open circuit voltage, Voc (V)	37.46	38.01	38.11	38.61	38.81
Short circuit current, Isc (A)	8.71	8.93	8.99	9.04	9.1
Module efficiency (%)	15.18	15.49	15.79	16.09	16.40

*STC: Irradiance 1000 W/m², cell temperature 25°C, air mass AM1.5 according to EN 60904-3. Average efficiency reduction of 4.5 % at 200 W/m² according to EN 60904-1. Except Pmp, all other parameters have a tolerance of +/-3 %, measurement uncertainty <3 %

Electrical parameters at NOCT

Power(Wp) at NOCT	184.4	18.2	191.5	195.8	199.1
V@Pmax(V) at NOCT	27.32	2.66	27.71	28.01	28.08
I@Pmax (A) at NOCT	6.75	6.83	6.91	6.99	7.09
Voc (V) at NOCT	34.75	34.88	34.92	35.08	35.1
Isc (A) at NOCT	7.23	7.3	7.37	7.45	7.52

*NOCT irradiance 800 W/m², ambient temperature 20°C, wind speed 1 m/sec

Temperature co-efficients (TC) and permissible operating conditions

TC of open circuit voltage (β)	- 0.31 % /°C
TC of short circuit current (α)	0.069 % /°C
TC of power (γ)	- 0.40 % /°C
Maximum system voltage	1000/1500 V (IEC & UL)
NOCT	44°C ± 2°C
Temperature range	- 40°C to + 85°C

Packing information

Container	40'HC
Pallets / Container	24
Pieces / Container	700

Warranty and certifications

Product warranty**
12 years of product warranty

Performance guarantee**
Power Degradation < - 2.5 % in first year < - 0.68 % / year in 2-25 years

Approvals and certificates: IEC 61215 Ed2, IEC 61730, IEC 61701, UL 1703, MCS, JET, CEC, CEC-Aus, IEC 62716, IEC 62759, IEC 62782, IEC 60068-2-68, IEC 61853, IS 14286, IS 61730



Mechanical data

Length	1660 mm
Width	992 mm
Height	35 mm / 40 mm
Weight	17.5 Kg (35 mm) x 18.8 Kg (40 mm)
Junction box	IP68
Cable and connectors	1200 mm length cable, MC4 & Amphenol compatible connectors
Application class	Class A (Safety class II)
Superstrate	High transmittance ARC glass
Cells	60 multi-crystalline solar cells; 5 bus bars; 156.75 x 156.75 mm
Encapsulation	EVA
Substrate	Tri layer backsheet
Frame	Anodized aluminium frame with twin wall profile
Mechanical load test as per IEC & UL	5400 Pa-front ; 2400 Pa-back
Maximum series fuse rating	15 A

Note:

- The specifications included in this datasheet are subject to change without notice.
- The electrical data given here is for reference purpose only.
- Please confirm your exact requirements with the sales representative while placing your order. All modules sold will be as per MSPVL MQAP

**** Warranty:**

Please read Adani solar warranty documents thoroughly.

Share Your Query :

***Caution:**

Please read safety and installation instructions before using the product.